

WIRE MANAGEMENT SOLUTIONS

Wiring Ducts

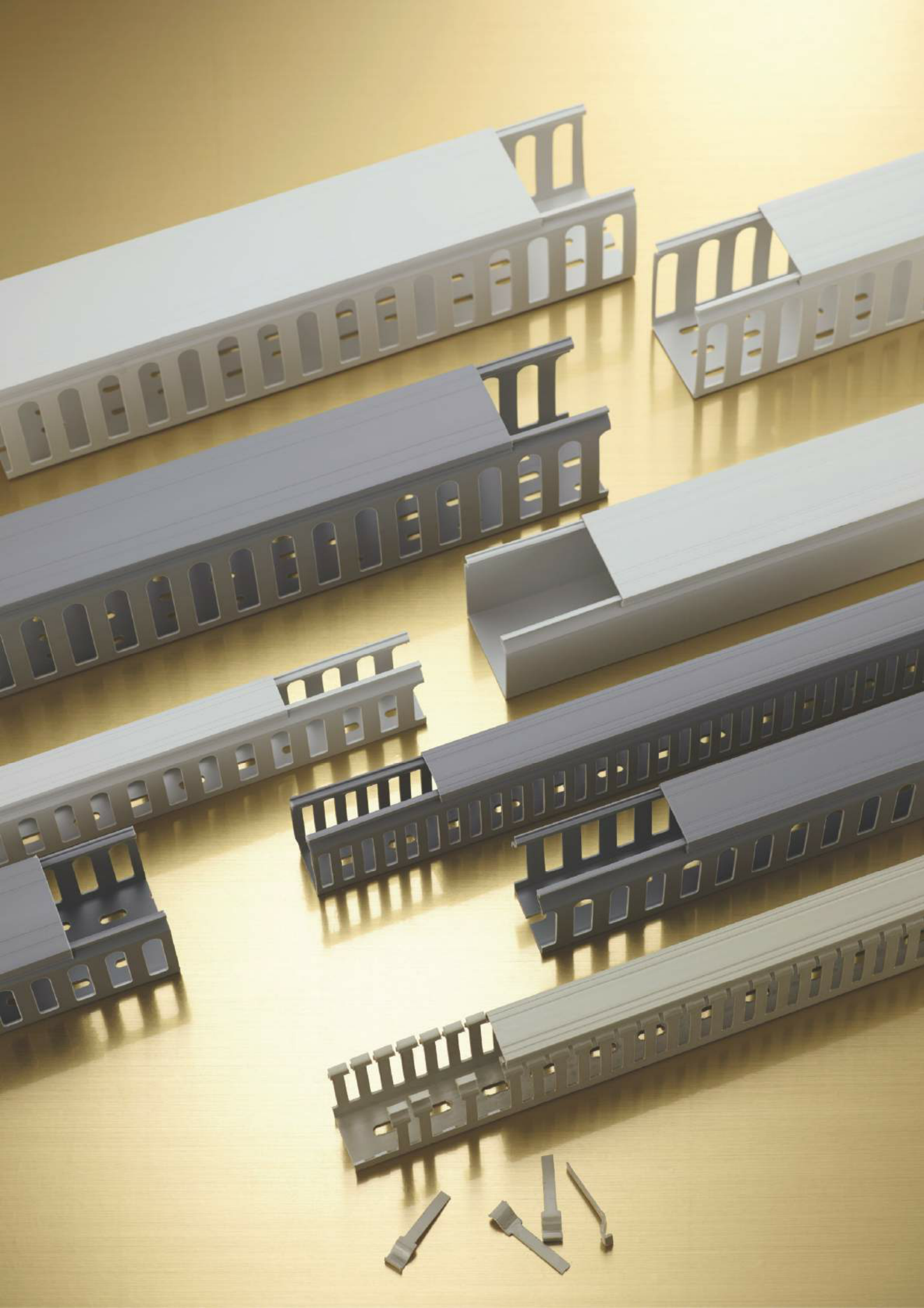

KUMCHANG CO., LTD.



Contents

Wiring Duct (PVC)

Wide close slot wiring duct (표준형)	2
Narrow close slot wiring duct (조밀형)	3
Wide slot wiring duct (개방형)	4
Narrow wide slot wiring duct (조밀개방형)	5
Solid slot wiring duct (밀폐형)	6

Wiring Duct (ABS)

Wide close slot wiring duct (표준형)	7
Narrow close slot wiring duct (조밀형)	8
Wide slot wiring duct (개방형)	9
Narrow wide slot wiring duct (조밀개방형)	10
Solid slot wiring duct (밀폐형)	11

Wiring Duct (ABS - Halogen Free)

Wide close slot wiring duct (표준형)	12
Narrow close slot wiring duct (조밀형)	13
Wide slot wiring duct (개방형)	14
Narrow wide slot wiring duct (조밀개방형)	15
Solid slot wiring duct (밀폐형)	16

Accessories

Duct washer bolt	17
Wiring duct cutter	17
Hook band, Hook band-black	18
Cable shield tube	19
Terminal caps	20
Eye tubular cable lug thermo caps	20
Thermo terminal caps, Thermo sensor cap	21

Terminals

Ring terminals - Non-insulated (KS, UL) ...	22~24
Ring terminals - PVC insulated (KS, UL) ..	25~26
Ring terminals - Nylon insulated (KS, UL) ..	27~28
Ring terminals - Non-insulated	29~30
Non-insulated terminals-Type(Fork, Blade, Pin) ...	31
Ring terminals - PVC insulated	32
Ring terminals - Nylon insulated	33
PVC insulated terminals-Type(Fork, Blade, Pin) ..	34
Nylon insulated terminals-Type(Fork, Blade, Pin) ..	35

Tubular Cable Lugs

Tubular cable lugs, One hole (Type-CE)	36~37
Tubular cable lugs, Two hole (Type-CE)	38
Tubular cable lugs, One hole (Type-CP) (UL) ..	39~40
Tubular cable lugs, Two hole (Type-CP) (UL) ..	41

Cable Ties

Cable ties - Nylon 6.6	42
Cable ties - Flammability Nylon 6.6	43
Cable ties - Weather resistant Nylon 6.6	44

Appendix

Certificate for Business Registration	45
Certificate of Patent	46
Certificate of Design Registration	47
Certificate of Related Design Registration	48

Wide Close Slot Wiring Duct (표준형)

- Material : PVC
- Temperature rating : 50°C
- Color : Grey, Ivory
- Other color is available to special order
- Flammability : UL94 V-0

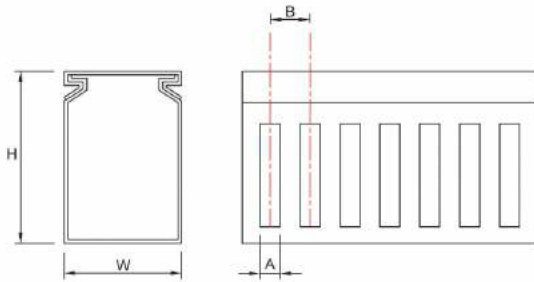
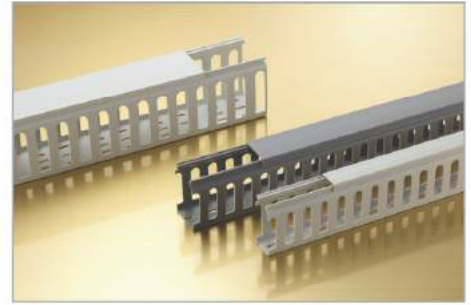

<Typical side view>

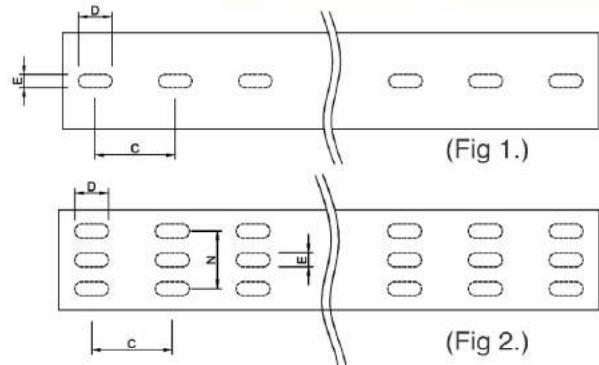

<Bottom mounting view>

Part Number	Hole Pattern Type	Dimension (mm)									
		W	H	A	B	C	D	E	N	Length	
KCWDA 20×35	Fig 1	20	35	10	20	50	15	6	-	2000	
KCWDA 25×40		25	40	10	20						
KCWDA 25×60		25	60	10	20						
KCWDA 30×40		30	40	10	20						
KCWDA 30×60		30	60	10	20						
KCWDA 30×80		30	80	10	20						
KCWDA 40×40		40	40	10	20						
KCWDA 40×60		40	60	10	20						
KCWDA 40×80		40	80	10	20						
KCWDA 40×100		40	100	10	20						
KCWDA 60×40	Fig 2	60	40	10	20	50	15	6	35	2000	
KCWDA 60×60		60	60	10	20						
KCWDA 60×80		60	80	10	20						
KCWDA 60×100		60	100	10	20						
KCWDA 60×120		60	120	10	20						
KCWDA 80×30		80	30	13	25				6		40
KCWDA 80×60		80	60	13	25						
KCWDA 80×80		80	80	13	25						
KCWDA 80×100		80	100	13	25						
KCWDA 80×120		80	120	13	25						
KCWDA 100×80	100	80	13	25	40						
KCWDA 100×100	100	100	13	25							
KCWDA 100×120	100	120	13	25							
KCWDA 150×100	150	100	13	25	90						

Narrow Close Slot Wiring Duct (조밀형)

- Material : PVC
- Temperature rating : 50°C
- Other color is available to special order
- Color : Grey, Ivory
- Flammability : UL94 V-0

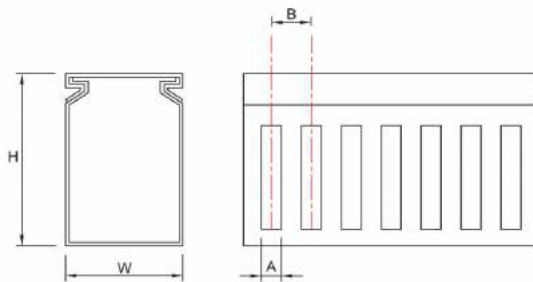
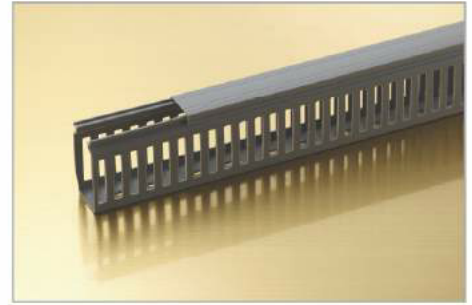

<Typical side view>

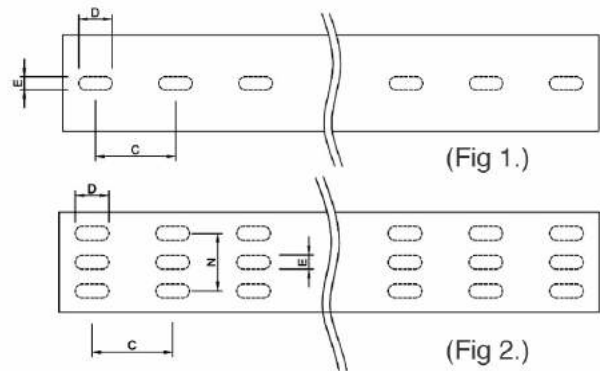

<Bottom mounting view>

Part Number	Hole Pattern Type	Dimension (mm)								
		W	H	A	B	C	D	E	N	Length
KCWDN 20×35	Fig 1	20	35	5	10	50	15	6		2000
KCWDN 25×40		25	40							
KCWDN 25×60		25	60							
KCWDN 30×40		30	40							
KCWDN 30×60		30	60							
KCWDN 30×80		30	80							
KCWDN 40×40		40	40							
KCWDN 40×60		40	60							
KCWDN 40×80		40	80							
KCWDN 40×100		40	100							
KCWDN 60×40	Fig 2	60	40	5	10	50	15	6	35	2000
KCWDN 60×60		60	60							
KCWDN 60×80		60	80							
KCWDN 60×100		60	100							
KCWDN 80×60		80	60							
KCWDN 80×80		80	80							
KCWDN 80×100		80	100							
KCWDN 100×80		100	80							
KCWDN 100×100	100	100								

Wide Slot Wiring Duct (개방형)

- Material : PVC
- Temperature rating : 50°C
- Color : Grey, Ivory
- Other color is available to special order
- Flammability : UL94 V-0

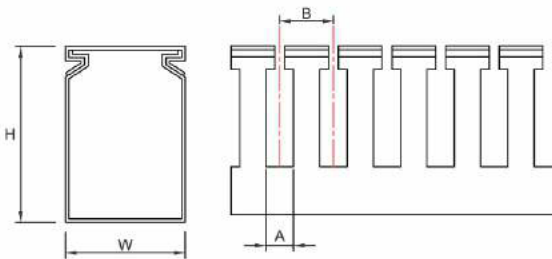

<Typical side view>

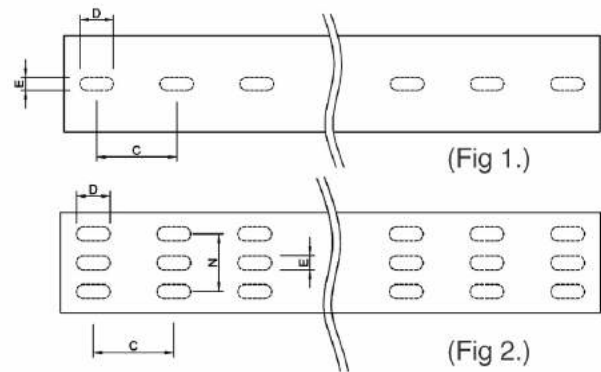

<Bottom mounting view>

Part Number	Hole Pattern Type	Dimension (mm)								
		W	H	A	B	C	D	E	N	Length
KCWDO 20×35	Fig 1	20	35	10	20	50	15	6	-	2000
KCWDO 25×40		25	40							
KCWDO 25×60		25	60							
KCWDO 30×40		30	40							
KCWDO 30×60		30	60							
KCWDO 30×80		30	80							
KCWDO 40×40		40	40							
KCWDO 40×60		40	60							
KCWDO 40×80		40	80							
KCWDO 40×100		40	100							
KCWDO 60×40	Fig 2	60	40	10	20	50	15	6	35	2000
KCWDO 60×60		60	60							
KCWDO 60×80		60	80							
KCWDO 60×100		60	100							
KCWDO 80×60		80	60							
KCWDO 80×80		80	80							
KCWDO 80×100		80	100							
KCWDO 100×80		100	80							
KCWDO 100×100	100	100								

Narrow Wide Slot Wiring Duct (조밀 개방형)

- Material : PVC
- Temperature rating : 50°C
- Color : Grey, Ivory
- Other color is available to special order
- Flammability : UL94 V-0

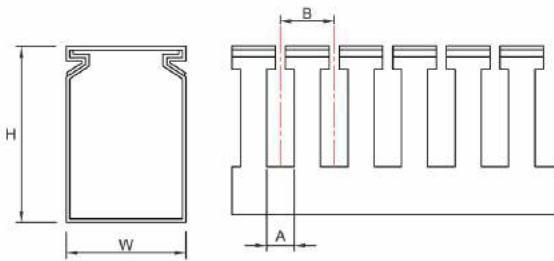

<Typical side view>

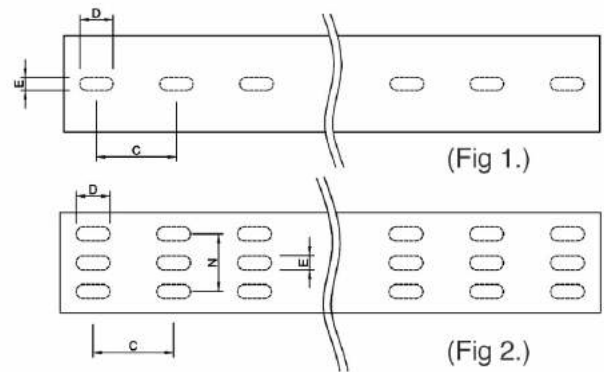

<Bottom mounting view>

Part Number	Hole Pattern Type	Dimension (mm)								
		W	H	A	B	C	D	E	N	Length
KCWDON 20×35	Fig 1	20	35	5	10	50	15	6	-	2000
KCWDON 25×40		25	40							
KCWDON 25×60		25	60							
KCWDON 30×40		30	40							
KCWDON 30×60		30	60							
KCWDON 30×80		30	80							
KCWDON 40×40		40	40							
KCWDON 40×60		40	60							
KCWDON 40×80		40	80							
KCWDON 40×100		40	100							
KCWDON 60×40	Fig 2	60	40	5	10	50	15	6	35	2000
KCWDON 60×60		60	60							
KCWDON 60×80		60	80							
KCWDON 60×100		60	100							
KCWDON 80×60		80	60							
KCWDON 80×80		80	80							
KCWDON 80×100		80	100							
KCWDON 100×80		100	80							
KCWDON 100×100	100	100								

Solid Slot Wiring Duct (밀폐형)

- Material : PVC
- Temperature rating : 50°C
- Color : Grey, Ivory
- Other color is available to special order
- Flammability : UL94 V-0

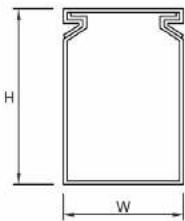

Part Number	Dimension (mm)			Part Number	Dimension (mm)		
	W	H	Length		W	H	Length
KCWDC 20×35	20	35	2000	KCWDC 60×40	60	40	2000
KCWDC 25×40	25	40		KCWDC 60×60	60	60	
KCWDC 25×60	25	60		KCWDC 60×80	60	80	
KCWDC 30×40	30	40		KCWDC 60×100	60	100	
KCWDC 30×60	30	60		KCWDC 80×60	80	60	
KCWDC 30×80	30	80		KCWDC 80×80	80	80	
KCWDC 40×40	40	40		KCWDC 80×100	80	100	
KCWDC 40×60	40	60		KCWDC 100×80	100	80	
KCWDC 40×80	40	80		KCWDC 100×100	100	100	
KCWDC 40×100	40	100					

Wide Close Slot Wiring Duct - ABS (표준형)

- Material : ABS
- Temperature rating : 85°C
- Color : Ivory
- Flammability : UL94 V-0

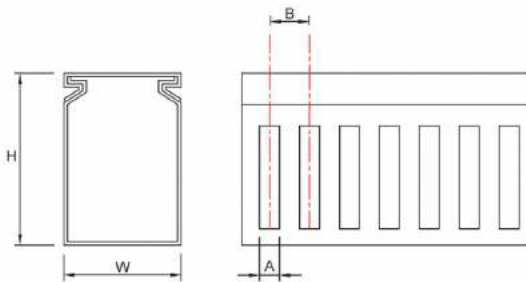
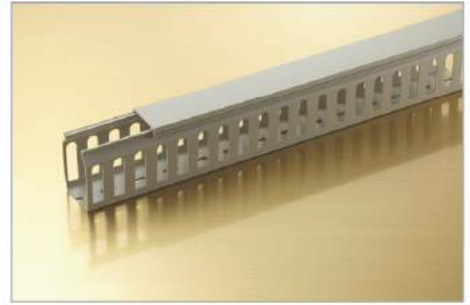

<Typical side view>

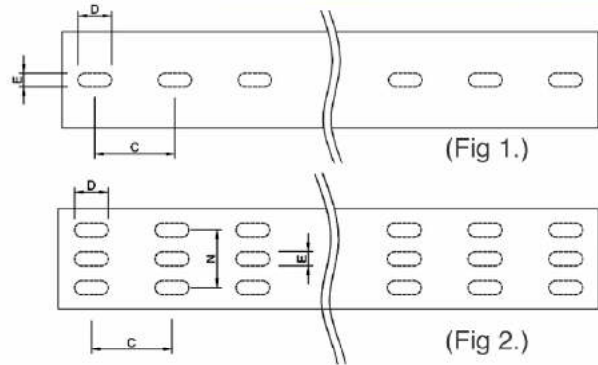

<Bottom mounting view>

Part Number	Hole Pattern Type	Dimension (mm)								
		W	H	A	B	C	D	E	N	Length
KCWDH 20×35A	Fig 1	20	35	10	20	50	15	6	-	2000
KCWDH 25×40A		25	40	10	20					
KCWDH 25×60A		25	60	10	20					
KCWDH 30×40A		30	40	10	20					
KCWDH 30×60A		30	60	10	20					
KCWDH 30×80A		30	80	10	20					
KCWDH 40×40A		40	40	10	20					
KCWDH 40×60A		40	60	10	20					
KCWDH 40×80A		40	80	10	20					
KCWDH 40×100A		40	100	10	20					
KCWDH 60×40A	Fig 2	60	40	10	20	50	15	6	35	2000
KCWDH 60×60A		60	60	10	20					
KCWDH 60×80A		60	80	10	20					
KCWDH 60×100A		60	100	10	20					
KCWDH 60×120A		60	120	10	20					
KCWDH 80×30A		80	30	13	25					
KCWDH 80×60A		80	60	13	25					
KCWDH 80×80A		80	80	13	25					
KCWDH 80×100A		80	100	13	25					
KCWDH 80×120A		80	120	13	25					
KCWDH 100×80A	100	80	13	25	6	40				
KCWDH 100×100A	100	100	13	25						
KCWDH 100×120A	100	120	13	25						
KCWDH 150×100A	150	100	13	25						

Narrow Close Slot Wiring Duct - ABS (조밀형)

- Material : ABS
- Temperature rating : 85°C
- Color : Ivory
- Flammability : UL94 V-0

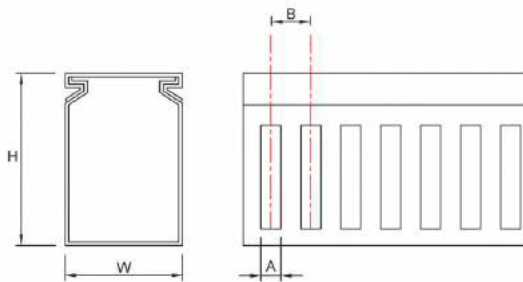

<Typical side view>

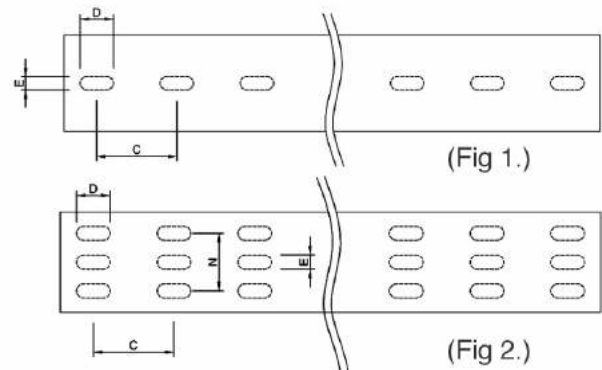

<Bottom mounting view>

Part Number	Hole Pattern Type	Dimension (mm)								
		W	H	A	B	C	D	E	N	Length
KCWDHN 20×35A	Fig 1	20	35	5	10	50	15	6		2000
KCWDHN 25×40A		25	40							
KCWDHN 25×60A		25	60							
KCWDHN 30×40A		30	40							
KCWDHN 30×60A		30	60							
KCWDHN 30×80A		30	80							
KCWDHN 40×40A		40	40							
KCWDHN 40×60A		40	60							
KCWDHN 40×80A		40	80							
KCWDHN 40×100A		40	100							
KCWDHN 60×40A	Fig 2	60	40	5	10	50	15	6	35	2000
KCWDHN 60×60A		60	60							
KCWDHN 60×80A		60	80							
KCWDHN 60×100A		60	100							
KCWDHN 80×60A		80	60							
KCWDHN 80×80A		80	80							
KCWDHN 80×100A		80	100							
KCWDHN 100×80A		100	80							
KCWDHN 100×100A	100	100								

Wide Slot Wiring Duct - ABS (개방형)

- Material : ABS
- Temperature rating : 85°C
- Color : Ivory
- Flammability : UL94 V-0

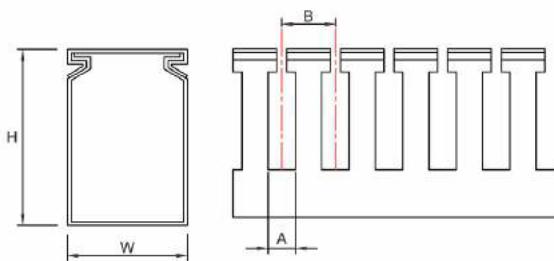

<Typical side view>

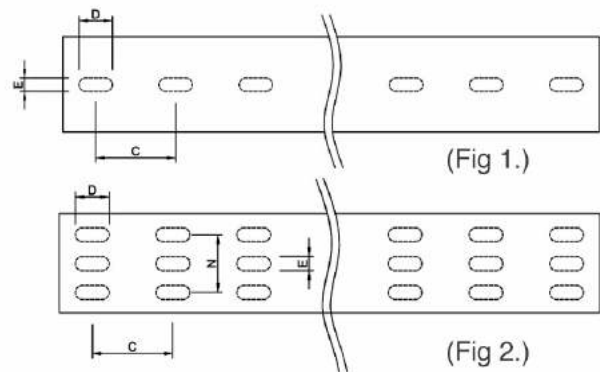

<Bottom mounting view>

Part Number	Hole Pattern Type	Dimension (mm)								
		W	H	A	B	C	D	E	N	Length
KCWDHO 20×35A	Fig 1	20	35	10	20	50	15	6	-	2000
KCWDHO 25×40A		25	40							
KCWDHO 25×60A		25	60							
KCWDHO 30×40A		30	40							
KCWDHO 30×60A		30	60							
KCWDHO 30×80A		30	80							
KCWDHO 40×40A		40	40							
KCWDHO 40×60A		40	60							
KCWDHO 40×80A		40	80							
KCWDHO 40×100A		40	100							
KCWDHO 60×40A	Fig 2	60	40	10	20	50	15	6	35	2000
KCWDHO 60×60A		60	60							
KCWDHO 60×80A		60	80							
KCWDHO 60×100A		60	100							
KCWDHO 80×60A		80	60							
KCWDHO 80×80A		80	80							
KCWDHO 80×100A		80	100							
KCWDHO 100×80A		100	80							
KCWDHO 100×100A	100	100								

Narrow Wide Slot Wiring Duct - ABS (조밀 개방형)

- Material : ABS
- Temperature rating : 85°C
- Color : Ivory
- Flammability : UL94 V-0

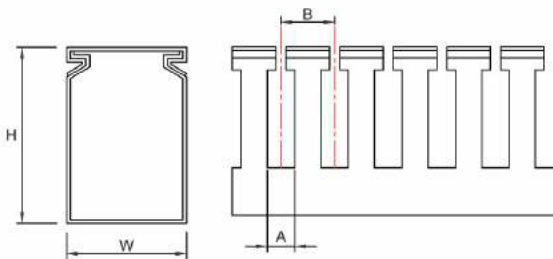
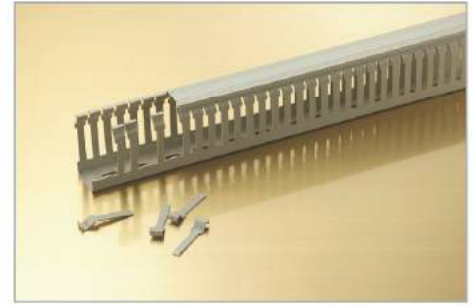

<Typical side view>

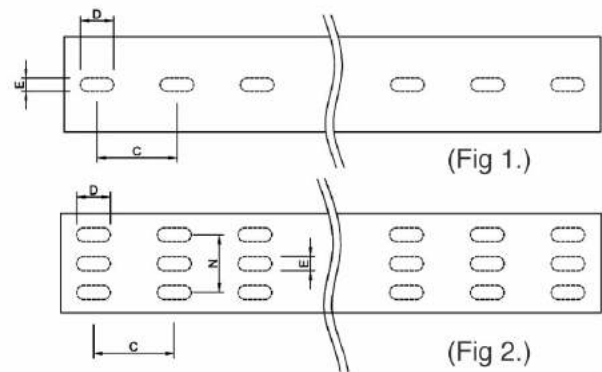

(Fig 1.)

(Fig 2.)

<Bottom mounting view>

Part Number	Hole Pattern Type	Dimension (mm)								
		W	H	A	B	C	D	E	N	Length
KCWDHON 20×35A	Fig 1	20	35	5	10	50	15	6	-	2000
KCWDHON 25×40A		25	40							
KCWDHON 25×60A		25	60							
KCWDHON 30×40A		30	40							
KCWDHON 30×60A		30	60							
KCWDHON 30×80A		30	80							
KCWDHON 40×40A		40	40							
KCWDHON 40×60A		40	60							
KCWDHON 40×80A		40	80							
KCWDHON 40×100A		40	100							
KCWDHON 60×40A	Fig 2	60	40	5	10	50	15	6	35	2000
KCWDHON 60×60A		60	60							
KCWDHON 60×80A		60	80							
KCWDHON 60×100A		60	100							
KCWDHON 80×60A		80	60							
KCWDHON 80×80A		80	80							
KCWDHON 80×100A		80	100							
KCWDHON 100×80A		100	80							
KCWDHON 100×100A	100	100								

Solid Slot Wiring Duct - ABS (밀폐형)

- Material : ABS
- Temperature rating : 85°C
- Color : Ivory
- Flammability : UL94 V-0

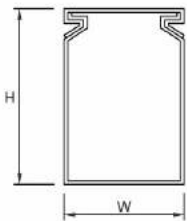

Part Number	Dimension (mm)			Part Number	Dimension (mm)		
	W	H	Length		W	H	Length
KCWDHC 20×35A	20	35	2000	KCWDHC 60×40A	60	40	2000
KCWDHC 25×40A	25	40		KCWDHC 60×60A	60	60	
KCWDHC 25×60A	25	60		KCWDHC 60×80A	60	80	
KCWDHC 30×40A	30	40		KCWDHC 60×100A	60	100	
KCWDHC 30×60A	30	60		KCWDHC 80×60A	80	60	
KCWDHC 30×80A	30	80		KCWDHC 80×80A	80	80	
KCWDHC 40×40A	40	40		KCWDHC 80×100A	80	100	
KCWDHC 40×60A	40	60		KCWDHC 100×80A	100	80	
KCWDHC 40×80A	40	80		KCWDHC 100×100A	100	100	
KCWDHC 40×100A	40	100					

Wide Close Slot Wiring Duct - Halogen Free (표준형)

- Material : ABS - Halogen free
- Temperature rating : 60°C
- Color : Ivory
- Flammability : UL94 V-2

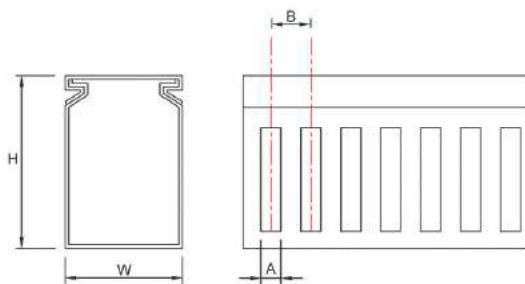
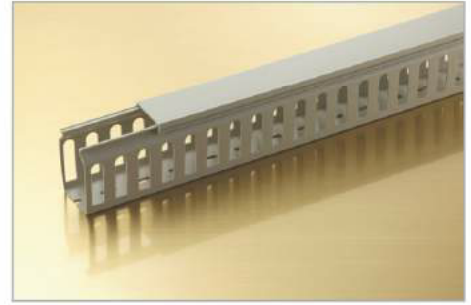

<Typical side view>

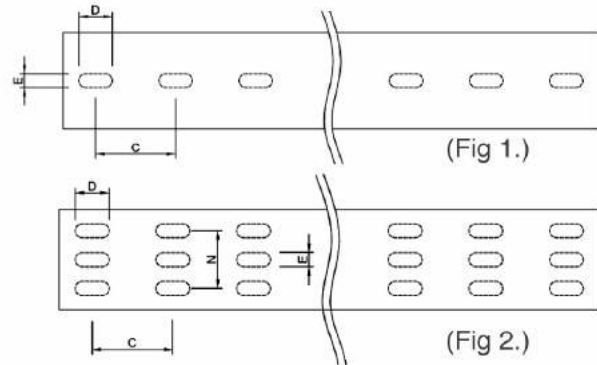

<Bottom mounting view>

Part Number	Hole Pattern Type	Dimension (mm)								
		W	H	A	B	C	D	E	N	Length
KCWDH 20×35	Fig 1	20	35	10	20	50	15	6	-	2000
KCWDH 25×40		25	40	10	20					
KCWDH 25×60		25	60	10	20					
KCWDH 30×40		30	40	10	20					
KCWDH 30×60		30	60	10	20					
KCWDH 30×80		30	80	10	20					
KCWDH 40×40		40	40	10	20					
KCWDH 40×60		40	60	10	20					
KCWDH 40×80		40	80	10	20					
KCWDH 40×100		40	100	10	20					
KCWDH 60×40	Fig 2	60	40	10	20	50	15	6	35	2000
KCWDH 60×60		60	60	10	20					
KCWDH 60×80		60	80	10	20					
KCWDH 60×100		60	100	10	20					
KCWDH 60×120		60	120	10	20					
KCWDH 80×30		80	30	13	25					
KCWDH 80×60		80	60	13	25					
KCWDH 80×80		80	80	13	25					
KCWDH 80×100		80	100	13	25					
KCWDH 80×120		80	120	13	25					
KCWDH 100×80		100	80	13	25			6	40	2000
KCWDH 100×100		100	100	13	25					
KCWDH 100×120		100	120	13	25					
KCWDH 150×100		150	100	13	25					

Narrow Close Slot Wiring Duct - Halogen Free (조밀형)

- Material : ABS - Halogen free
- Temperature rating : 60°C
- Color : Ivory
- Flammability : UL94 V-2

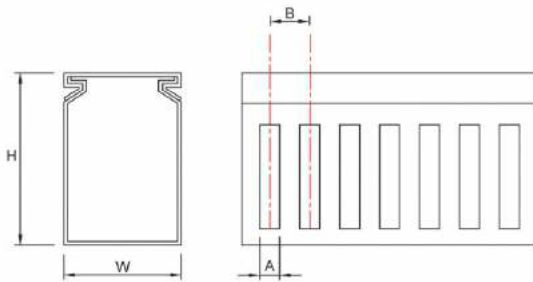
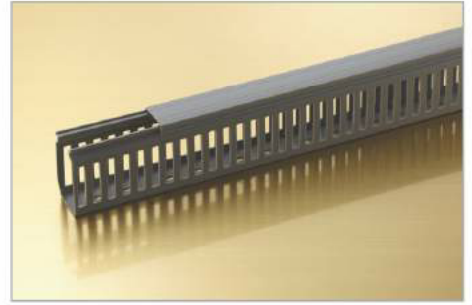

<Typical side view>

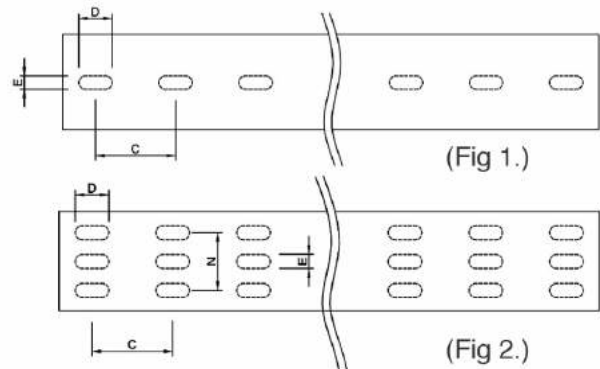

<Bottom mounting view>

Part Number	Hole Pattern Type	Dimension (mm)								
		W	H	A	B	C	D	E	N	Length
KCWDHN 20×35	Fig 1	20	35	5	10	50	15	6	-	2000
KCWDHN 25×40		25	40							
KCWDHN 25×60		25	60							
KCWDHN 30×40		30	40							
KCWDHN 30×60		30	60							
KCWDHN 30×80		30	80							
KCWDHN 40×40		40	40							
KCWDHN 40×60		40	60							
KCWDHN 40×80		40	80							
KCWDHN 40×100		40	100							
KCWDHN 60×40	Fig 2	60	40	5	10	50	15	6	35	2000
KCWDHN 60×60		60	60							
KCWDHN 60×80		60	80							
KCWDHN 60×100		60	100							
KCWDHN 80×60		80	60							
KCWDHN 80×80		80	80							
KCWDHN 80×100		80	100							
KCWDHN 100×80		100	80							
KCWDHN 100×100	100	100								

Wide Slot Wiring Duct - Halogen Free (개방형)

- Material : ABS - Halogen free
- Temperature rating : 60°C
- Color : Ivory
- Flammability : UL94 V-2

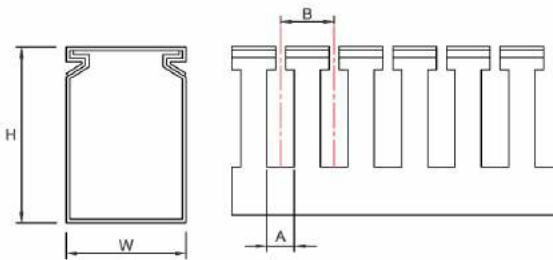

<Typical side view>

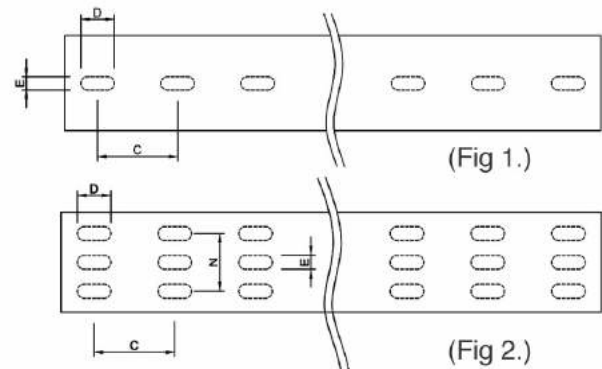

<Bottom mounting view>

Part Number	Hole Pattern Type	Dimension (mm)								
		W	H	A	B	C	D	E	N	Length
KCWDHO 20×35	Fig 1	20	35	10	20	50	15	6	-	2000
KCWDHO 25×40		25	40							
KCWDHO 25×60		25	60							
KCWDHO 30×40		30	40							
KCWDHO 30×60		30	60							
KCWDHO 30×80		30	80							
KCWDHO 40×40		40	40							
KCWDHO 40×60		40	60							
KCWDHO 40×80		40	80							
KCWDHO 40×100		40	100							
KCWDHO 60×40	Fig 2	60	40	10	20	50	15	6	35	2000
KCWDHO 60×60		60	60							
KCWDHO 60×80		60	80							
KCWDHO 60×100		60	100							
KCWDHO 80×60		80	60							
KCWDHO 80×80		80	80							
KCWDHO 80×100		80	100							
KCWDHO 100×80		100	80							
KCWDHO 100×100		100	100							
KCWDHO 100×100		100	100							

Wide Slot Wiring Duct - Halogen Free (조밀 개방형)

- Material : ABS - Halogen free
- Temperature rating : 60°C
- Color : Ivory
- Flammability : UL94 V-2

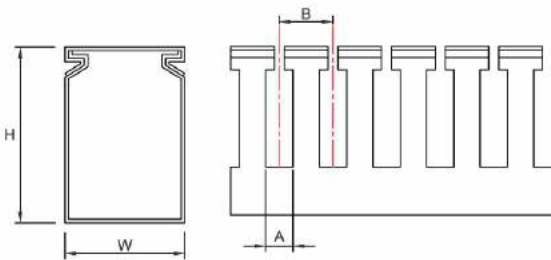
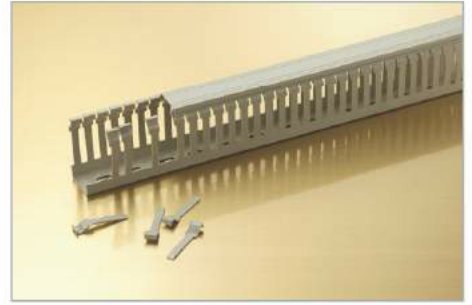

<Typical side view>

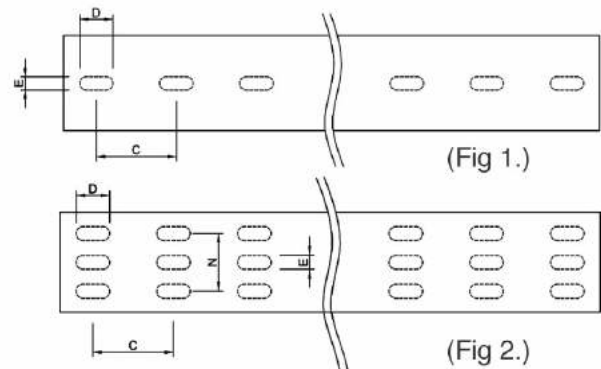

<Bottom mounting view>

Part Number	Hole Pattern Type	Dimension (mm)								
		W	H	A	B	C	D	E	N	Length
KCWDHON 20×35	Fig 1	20	35	10	20	50	15	6	-	2000
KCWDHON 25×40		25	40							
KCWDHON 25×60		25	60							
KCWDHON 30×40		30	40							
KCWDHON 30×60		30	60							
KCWDHON 30×80		30	80							
KCWDHON 40×40		40	40							
KCWDHON 40×60		40	60							
KCWDHON 40×80		40	80							
KCWDHON 40×100		40	100							
KCWDHON 60×40	Fig 2	60	40	10	20	50	15	6	35	2000
KCWDHON 60×60		60	60							
KCWDHON 60×80		60	80							
KCWDHON 60×100		60	100							
KCWDHON 80×60		80	60							
KCWDHON 80×80		80	80							
KCWDHON 80×100		80	100							
KCWDHON 100×80		100	80							
KCWDHON 100×100	100	100								

Solid Slot Wiring Duct - Halogen Free (밀폐형)

- Material : ABS - Halogen free
- Temperature rating : 60°C
- Color : Ivory
- Flammability : UL94 V-2

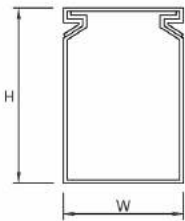

Part Number	Dimension (mm)			Part Number	Dimension (mm)		
	W	H	Length		W	H	Length
KCWDHC 20×35	20	35	2000	KCWDHC 60×40	60	40	2000
KCWDHC 25×40	25	40		KCWDHC 60×60	60	60	
KCWDHC 25×60	25	60		KCWDHC 60×80	60	80	
KCWDHC 30×40	30	40		KCWDHC 60×100	60	100	
KCWDHC 30×60	30	60		KCWDHC 80×60	80	60	
KCWDHC 30×80	30	80		KCWDHC 80×80	80	80	
KCWDHC 40×40	40	40		KCWDHC 80×100	80	100	
KCWDHC 40×60	40	60		KCWDHC 100×80	100	80	
KCWDHC 40×80	40	80		KCWDHC 100×100	100	100	
KCWDHC 40×100	40	100					

Duct Washer Bolt

- Material : ABS
- Flammability : UL94 V-0
- Color : Ivory

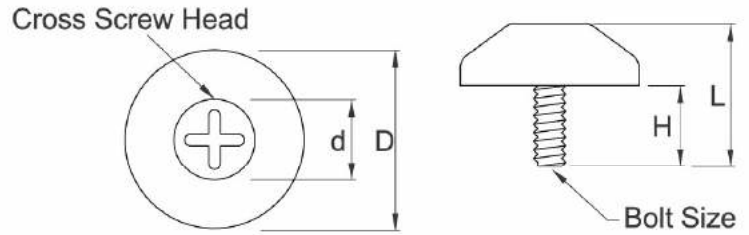

Part Number	Bolt Size	Dimension (mm)			
		d	D	H	L
KCDWB-408	M4	9.5	21	8	15
KCDWB-410	M4			10	17
KCDWB-510	M5			10	17

Wiring Duct Cutter



KL-42W
Width: Max. 100mm



KWT-3
Width: Max. 100mm
Weight: 8Kg

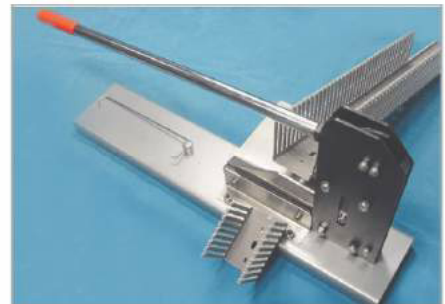

KWT-4
Width: Max. 130mm
Weight: 11Kg

Hook Band

- Material : Polyester Flame Retardant
- Coating : PVC
- Color : Gray



Part Number	Bundle Dia(Ø)	Width(mm)	Hook Pitch(mm)	Spool Quantity
KCHB-15	15	60	80	50M
KCHB-20	20	80		
KCHB-25	25	95		
KCHB-30	30	110		
KCHB-40	40	140		
KCHB-50	50	170		
KCHB-60	60	200		
KCHB-70	70	215		
KCHB-80	80	230		
KCHB-90	90	270		
KCHB-100	100	320		

Hook Band-Black

- Material : Polyester Flame Retardant
- Coating : PVC
- Color : Black



Part Number	Bundle Dia(Ø)	Width(mm)	Hook Pitch(mm)	Spool Quantity
KCHB-10B	10	60	80	50M
KCHB-15B	15	75		
KCHB-20B	20	90		
KCHB-25B	25	110		
KCHB-30B	30	125		
KCHB-40B	40	155		
KCHB-50B	50	190		
KCHB-60B	60	215		
KCHB-70B	70	250		
KCHB-80B	80	285		
KCHB-90B	90	315		
KCHB-100B	100	345		

Cable Shield Tube

- Material : PVC Film + PET Film + AL Foil (0.01mm)
- Flame Retardant : Same as UL94 VTM-O
- Operating Temperature : -15°C ~ 60°C

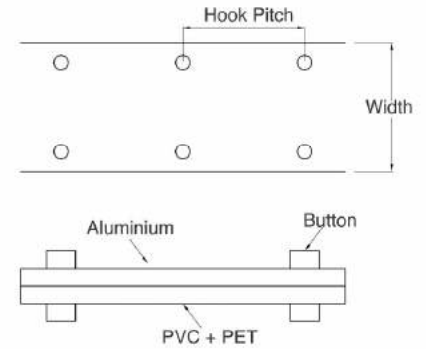

Part Number	Bundle Dia(Ø)	Width(mm)	Hook Pitch(mm)	Spool Quantity
KCST-10	10	60	80	50M
KCST-15	15	75		
KCST-20	20	90		
KCST-25	25	100		
KCST-30	30	125		
KCST-40	40	155		
KCST-50	50	190		
KCST-60	60	215		
KCST-70	70	250		
KCST-80	80	285		
KCST-90	90	315		
KCST-100	100	345		



Cable Shield Tube - Ground Wire

- Material : PVC Film + PET Film + AL Foil (0.01mm) +Ground Wire
- Flame Retardant : Same as UL94 VTM-O
- Operating Temperature : -15°C ~ 60°C
- Ground Wire : Tin plated Copper

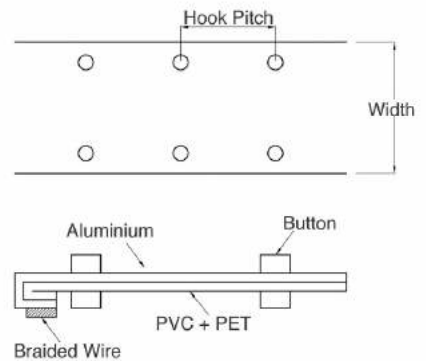

Part Number	Bundle Dia(Ø)	Width(mm)	Hook Pitch(mm)	Spool Quantity
KCST-10G	10	70	80	50M
KCST-15G	15	85		
KCST-20G	20	100		
KCST-25G	25	115		
KCST-30G	30	125		
KCST-40G	40	160		
KCST-50G	50	190		
KCST-60G	60	220		
KCST-70G	70	255		
KCST-80G	80	290		
KCST-90G	90	320		
KCST-100G	100	345		

